

NANLUX

Matrix 2500C
LED Full-color Multi-source Spot Light

USER MANUAL

Version: V1.1
2026-05-15

Revision History

Version	Date (Y-M-D)	Note
V1.0	2026-03-26	File First Publish
V1.1	2026-05-15	Minor adjustments

Contents

1. Introduction	1
2. Product Overview	2
2.1. Product Layout	2
2.2. Specifications	4
2.3. Includes	5
3. Safety Instructions	7
4. Installing Instructions	10
4.1. Connecting the Fixture with the Power Outlet	10
4.2. Installing and Detaching the Yoke	10
4.3. Installing and Detaching the Motorized Fresnel Lens	12
4.4. Motorized Fresnel Lens Usage	14
5. Operating Instructions	15
5.1. Lighting Mode Control	15
5.1.1. Control Panel Control	15
5.1.2. DMX Control	18
5.1.3. NANLINK APP Control-via Bluetooth	20
5.1.4. NANLINK APP Control-via NFC	21
5.1.5. NANLINK APP Control-via 2.4G	21
5.1.6. Remote Controller Control	22
5.1.7. CRMX Control	23
5.1.8. Art-Net&sACN Control	26
5.2. Menu	27
5.2.1. Menu Overview	27
5.2.2. Menu Operation	30
5.2.3. Others	30
5.3. Preset	32
5.3.1. Save Preset	33
5.3.2. Apply Preset	33
5.3.3. Manage Preset	34
5.4. Lock	34
5.5. NFC Function	35
6. Troubleshooting for Common Issues	36

1. Introduction

Thank you for purchasing the Nanlux product – Matrix 2500C!

The Matrix 2500C is a 2500W full-color multi-source spot light. It features an ultra-wide color temperature range of 1,000K to 20,000K and ± 200 green/magenta adjustment. Equipped with Nebula C8 light engine, it delivers precise and refined light quality, replicating natural and everyday lighting conditions such as sunlight and dim indoor lighting. With 15 built-in lighting effects, the Matrix 2500C can simulate various natural lighting scenarios and create cinematic looks. It offers multiple DMX modes to suit a wide range of applications. With an IP66 rating, the fixture ensures stable operation even in harsh environments. It supports a wide range of control methods, including on-board, wired controller, Nanlink App, DMX/RDM, CRMX, and Art-Net/sACN.

The Matrix 2500C will bring great convenience to your creation and inspire boundless creativity. Before using it, please read this manual carefully to ensure you can fully utilize all the features. Hope it can work with you to create more brilliant results together.

2. Product Overview

2.1. Product Layout

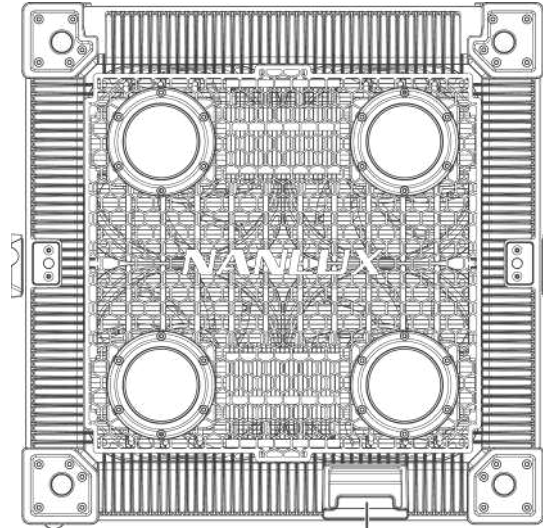

(1) Electronic Contacts

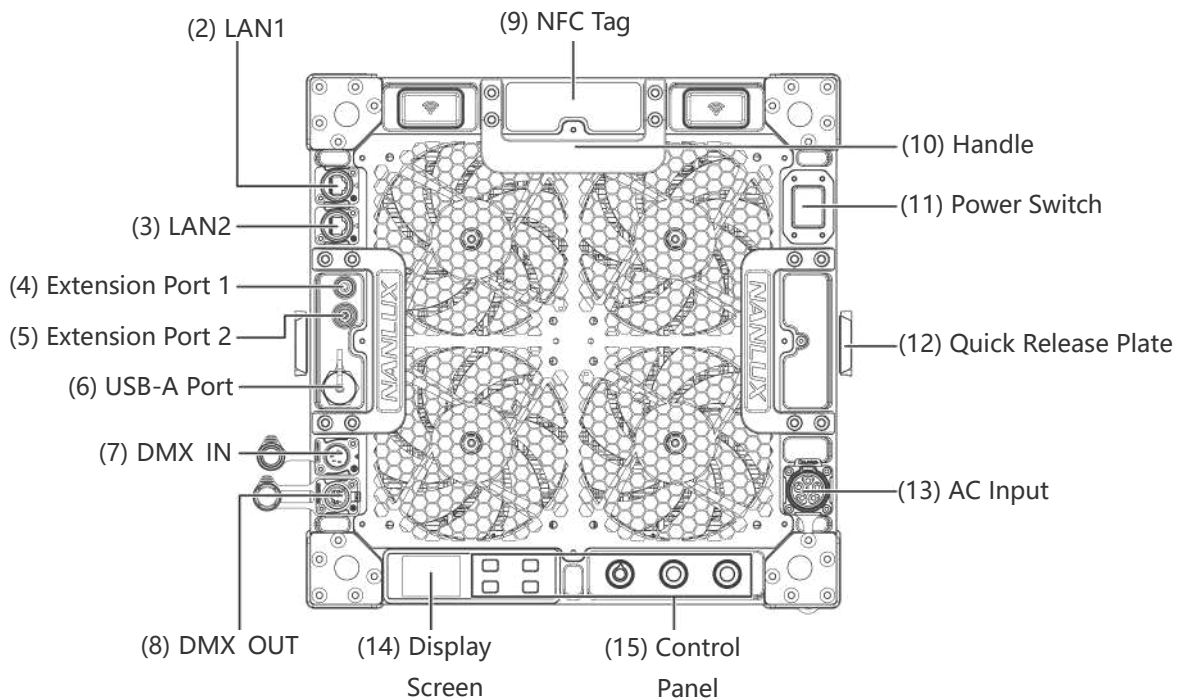

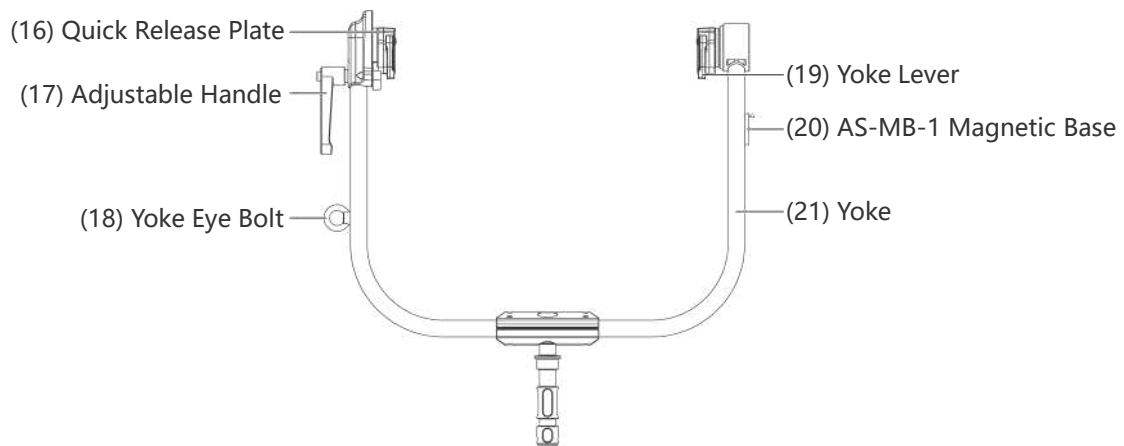





- (1) Electronic Contacts: For connecting with the accessory or for powering the motorized accessory.
- (2) LAN 1: Network connecting port.
- (3) LAN 2: Network connecting port.
- (4) Extension Port 1: For connecting the WC-EXT wired controller or other accessories.
- (5) Extension Port 2: For connecting the WC-EXT wired controller or other accessories.
- (6) USB-A Port: For updating the firmware.
- (7) DMX IN: For DMX signal input.
- (8) DMX OUT: For DMX signal output.
- (9) NFC Tag: For supporting NFC function.
- (10) Handle: For lifting the fixture and adjusting the direction of illumination.
- (11) Power Switch: For turning on/off the fixture.
- (12) Quick Release Plate: For attaching to the quick release plate base and mounting the fixture to the yoke.
- (13) AC Input: For connecting the power.
- (14) Display Screen: For displaying the lighting status and settings.
- (15) Control Panel: Includes four buttons and three knobs, for operating various functions.
- (16) Quick Release Plate Base: For attaching the quick release plate and mounting the fixture to the yoke.
- (17) Adjustable Handle: For adjusting and fixing the illumination direction of fixture.
- (18) Yoke Eye Bolt: For attaching the safety cable.
- (19) Yoke Lever: For locking and unlocking the yoke quick release plate.
- (20) AS-MB-1 Magnetic Base: For attaching the WC-EXT wired controller or other accessories.
- (21) Yoke: For mounting the fixture on a light stand and adjusting the tilt angle.

2.2. Specifications



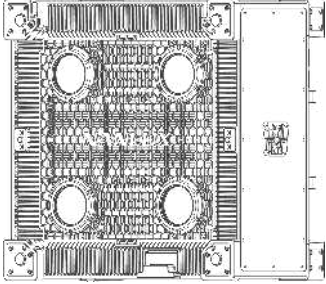
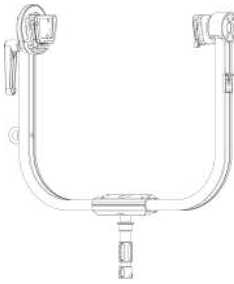
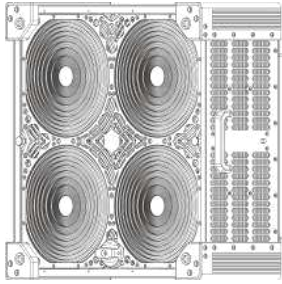

Model Name	Matrix 2500C
Rated Power	2500W
Input Voltage/Current	AC 100-240V/28A (Max) 50/60Hz
LED Light Engine	Nebula C8 Light Engine: dRRALGCBI (Deep Red, Red, Amber, Lime, Green, Cyan, Blue, Indigo)
CCT	1000K → 20000K (G/M±200)
CRI	Average 98
TLCI	Average 98
TM-30 Rf	Average 96
TM-30 Rg	Average 100
Dimming	0.0%-100.0%, by 0.1% increment
IP Rating	IP66
Control	On-board, Wired Controller, Remote Controller, NANLINK APP, DMX/RDM, CRMX, Art-Net/sACN
Special Effects	CCT Loop, INT Loop, HUE Loop, Flash, Pulse, Storm, Police Car, TV, Paparazzi, Candle/Fire, Disco, Bad Bulb, Firework, Explosion and Welding

2.3. Includes

Standard kit:

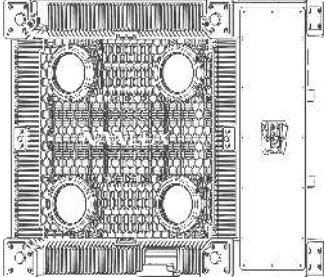
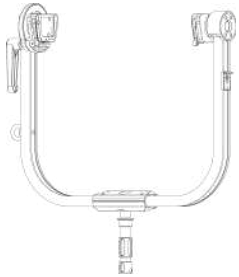
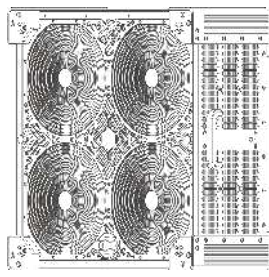
Matrix 2500C × 1		Yoke × 1		FL-MT25 Motorized Fresnel Lens × 1
				
AC Cable (two options, varies by voltage standards)				User Manual × 1
AC Power Cable × 1	AC Power Cable (with bare ends) × 1	AC Cable with Edison Connector × 1		
 220V-240V countries/regions	 100V-125V countries/regions			

Matrix 2500C KIT:

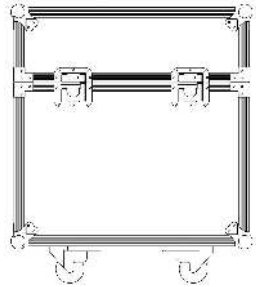
<p>Matrix 2500C × 1</p>	<p>Yoke × 1</p>	<p>FL-MT25 Motorized Fresnel Lens × 1</p>	<p>User Manual × 1</p>
			
<p>AC Cable (two options, varies by voltage standards)</p>			
<p>AC Power Cable × 1</p>	<p>AC Power Cable (with bare ends) × 1</p>	<p>AC Cable with Edison Connector × 1</p>	<p>Flight Case × 1</p>
 <p>220V-240V countries/regions</p>	 <p>100V-125V countries/regions</p>		

3. Safety Instructions

Please read and understand all safety instructions before installing or operating the fixture. Always follow the instructions to avoid personal injury and fixture damage.

Electrical:



Danger

Please ensure that the AC current, voltage and frequency comply with the fixture requirements, and make sure the fixture is properly grounded when connected.



Danger

Please use proper and undamaged cables to connect the fixture correctly, avoiding the risk of electric shock or fixture damage.



Danger

Please disconnect the power before moving or transporting the fixture.

Installation:



Danger

Please carefully read the manual and follow the instructions to install the fixture to avoid any unnecessary incidents.



Danger

Please use light stands or clamps that meet the load-bearing requirements to ensure the fixture's safety and stability when installing the fixture.



Danger

Please secure the fixture with a safety cable that can support at least 10 times the fixture's weight for overhead installation.



Caution

Please wear appropriate protective gloves when installing or removing the fixture or accessory with high-temperature surfaces.



Caution

Please pay special attention to the impact of wind and take appropriate reinforcement measures when installing outdoors.



Caution

When installing or detaching heavy accessories or adjusting the direction of the fixture, please hold the handle firmly to prevent accidental tilt down. Keep your hands away from the gap between the yoke and the fixture to avoid hand injuries.

Operation:



Danger

Please stop using the fixture immediately if the fixture housings or cables show visible damage.



Danger

Please do not use the fixture near flammable or explosive materials.



Danger

Please be cautious, as the flashing effect may trigger seizures.



Danger

The Matrix 2500C lamp head is rated IP66, providing complete protection against dust and resistance to water jets from all directions, including continuous exposure to heavy rain and washing with high-pressure water jets. However, please do not submerge the fixture in water to avoid personal injury or fixture damage.



Danger

Please keep the fixture away from corrosive liquids or high-pressure steam.



Caution

Please ensure the fixture is used in an environment between -20°C and 45°C; operating outside this temperature range may damage the fixture.



Caution

Please do not cover the ventilation openings during use to prevent the fixture from overheating.

 **Caution**

Please do not look directly at the light source without wearing protective glasses, as this may cause irreversible eye injury.

 **Caution**

Please remind the crew to avoid eye injury caused by accidentally looking directly at the light source before the fixture lights up.

Maintenance:

 **Danger**

Please do not disassemble or repair any part of the fixture on your own, as this will void the warranty. Maintenance and repair work should be carried out by an authorized service center and professional personnel.

 **Danger**

Please disconnect the power before starting any maintenance work.

 **Caution**

Please ensure the fixture is completely dry before transportation or storage after using it in a humid environment.

 **Notice**

Please ensure the fixture is stored away from the following environments or items: extreme temperatures, direct sunlight, high humidity, intense vibrations, dust, strong magnetic fields, and flammable or explosive materials.

 **Notice**

Please transport the fixture and accessories in suitable case to avoid damage.

4. Installing Instructions

4.1. Connecting the Fixture with the Power Outlet

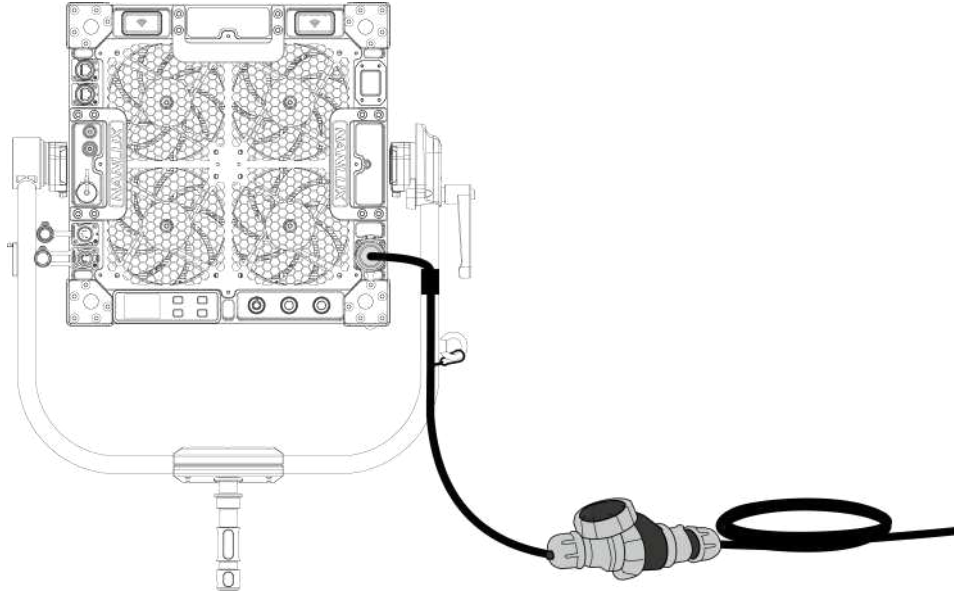

To power the fixture with AC power, please ensure the power switch is turned off, and connect the AC cable as shown above.

▲Note: If the fixture needs to be mounted on the yoke, it should be installed first before connecting the power.

4.2. Installing and Detaching the Yoke

Installation:

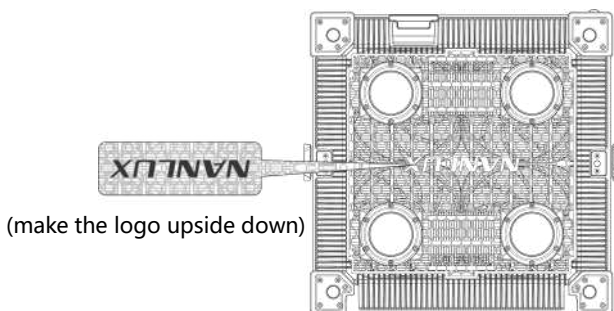

(1) Place the fixture on a flat surface with its bottom facing up.

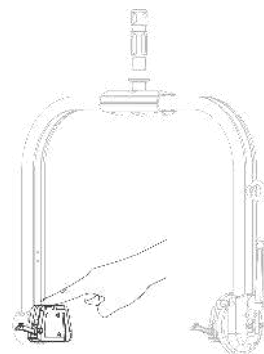

(2) Press the quick release lever lock catches and push them aside to release.

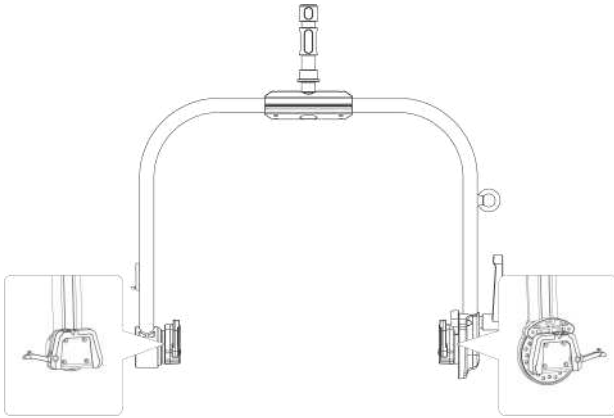

(3) Adjust the quick release plate bases on both sides of the yoke to make the angles of both plates are the same.

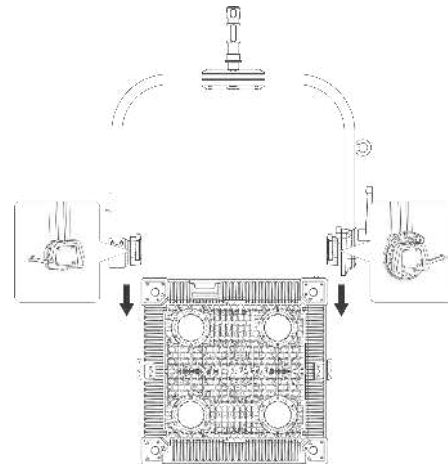

(4) Align and insert the quick release plate bases on both sides of yoke into the fixture's quick release plates.

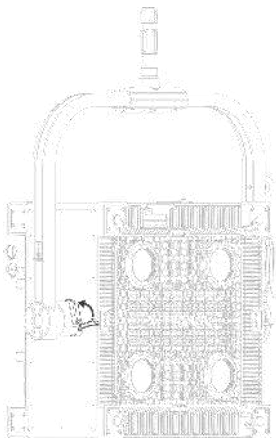

(5) Firmly hold the yoke in place with one hand, and pull the quick release lever with the other hand to lock the plate in place.

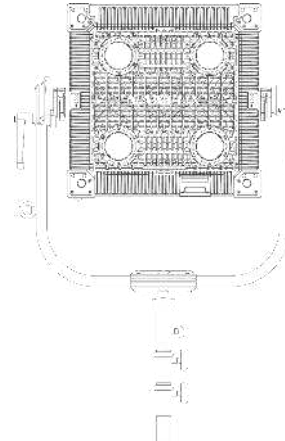

(6) Mount the fixture on heavy-duty light stand and tighten the knob on the light stand.

Detachment:

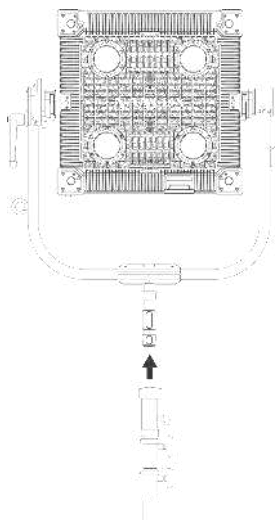

(1) To detach the yoke, first remove the fixture together with the yoke from the heavy-duty light stand and place it on a flat ground with the bottom facing up.

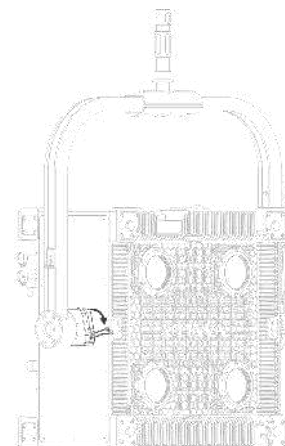

(2) Press the quick release lever lock catches on both sides and push them aside to release, then remove the yoke.

4.3. Installing and Detaching the Motorized Fresnel Lens

Installation:

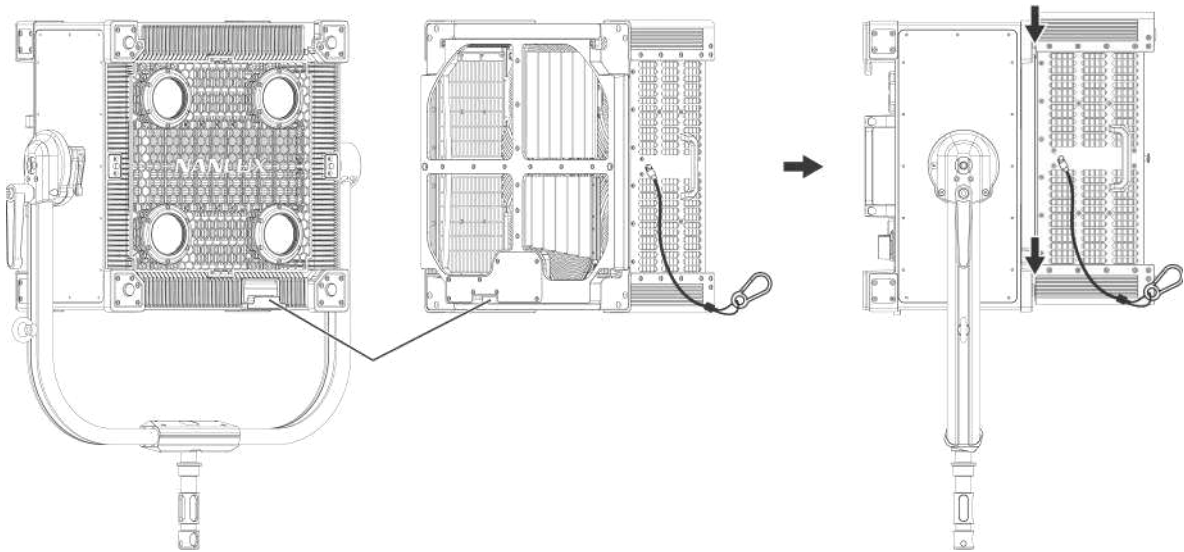

(1) Align the tabs on the back of the Fresnel lens with the fixture's slots, and insert them from top to bottom, until it is securely locked onto the fixture.

▲Note: Ensure that the electronic contacts on the Fresnel lens and the fixture are aligned.

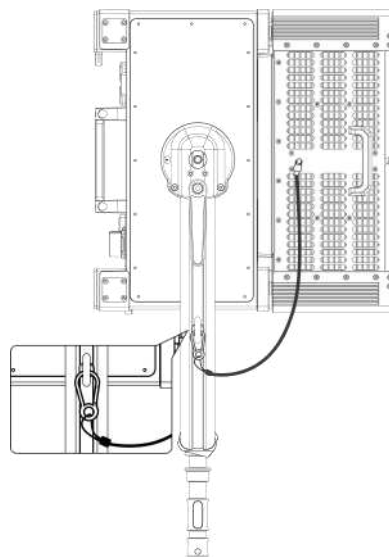

(2) Secure the Fresnel lens safety cable to the yoke eye bolt as shown above.

Detachment:

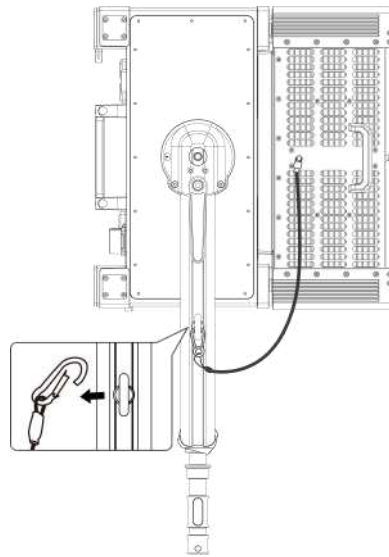

(1) To detach the Fresnel lens, release the safety cable first.

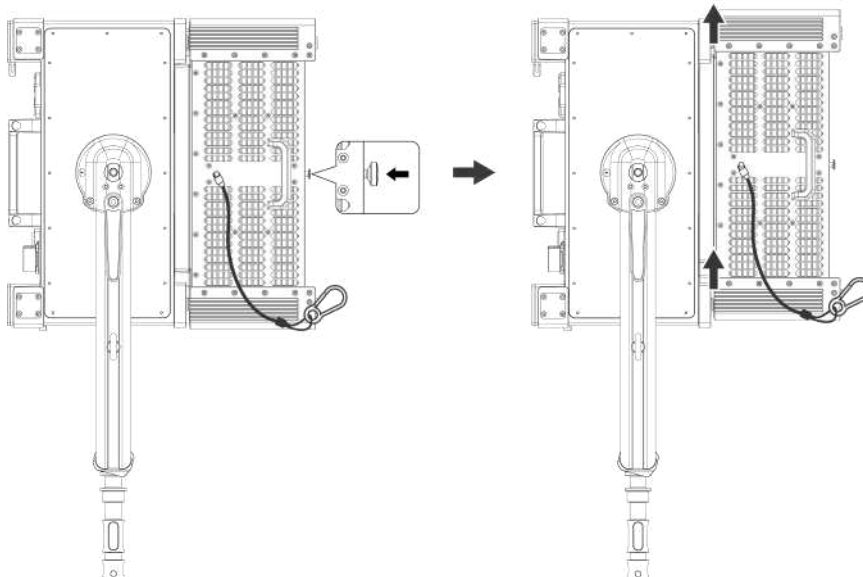

(2) Press the lock catches on both sides, then lift the Fresnel lens upward to detach it from the slots, and remove it from the fixture.

4.4. Motorized Fresnel Lens Usage

Manual Mode:

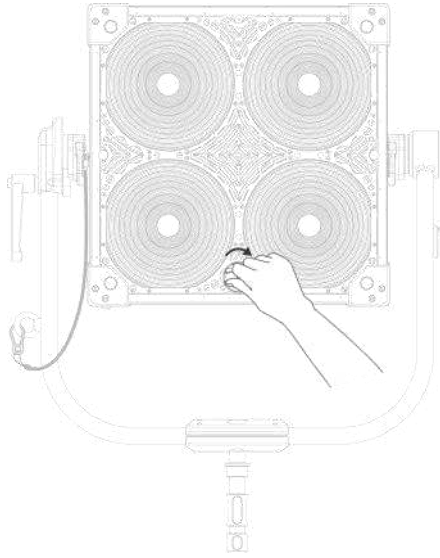

(1) Hold the knob down while rotating it clockwise to spot the light.

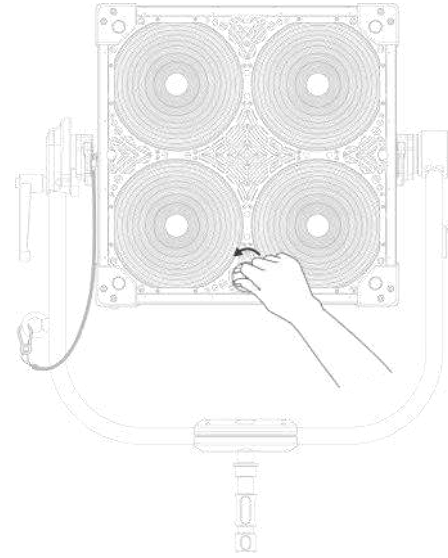

(2) Hold the knob down while rotating it anticlockwise to flood the light.

Motorized Mode:

Enter the zoom control interface: Menu → Light Control → Zoom Control

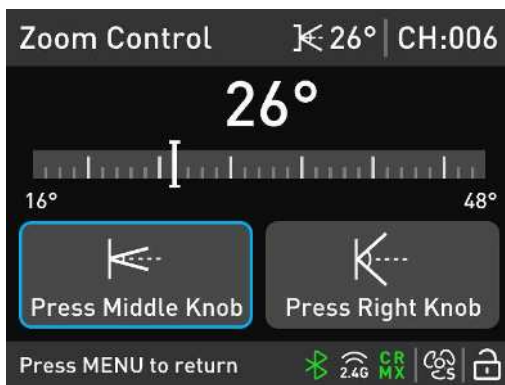

In this interface, long press the **middle knob** to spot the light.



Long press the **right knob** to flood the light.

5. Operating Instructions

Connect the fixture to power, turn on the power switch to power up the fixture.

The control panel features four buttons--**MODE**, **MENU**, **PRESET**, and **LOCK**, as well as three knobs: **left knob**, **middle knob**, and **right knob**.

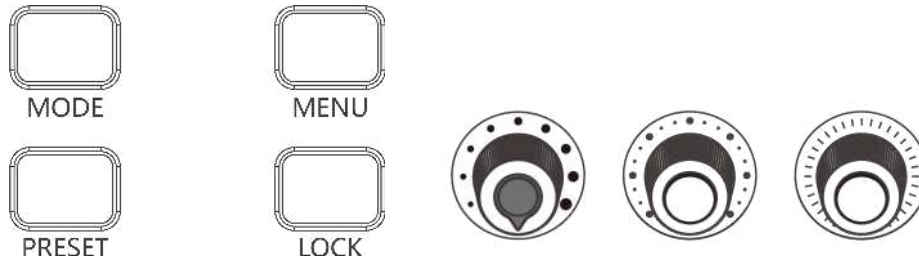

5.1. Lighting Mode Control

This fixture has CCT, HSI, HSIW, RGBW, XY Coordinates, Gel, and Effect modes.

5.1.1. Control Panel Control

(1) Mode Selection

Press the **MODE** button to enter the mode selection interface. Rotate the **right knob** to switch options, and press the **right knob** to enter the corresponding mode.

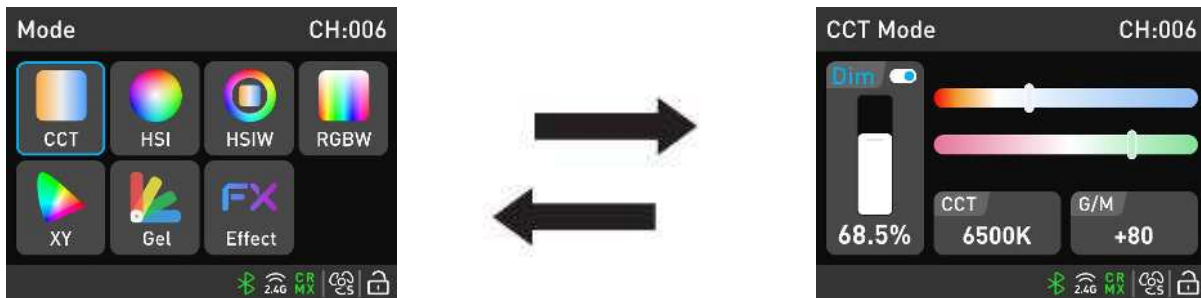

▲ Note: In the mode interface, press the **MODE** button to return to the mode selection interface.

(2) Mode Operation

① CCT Mode

Rotate the **left knob** to adjust brightness. Press the **left knob** to turn on or off the Dimmer Switch.

Rotate the **middle knob** to adjust the CCT. Press the **middle knob** to toggle among 1000K, 1200K, 1500K, 1800K, 2100K, 2400K, 2700K, 3200K, 4300K, 5600K, 6500K, 7500K, 8500K, 10000K, 12000K, 14000K, 16000K, 18000K, and 20000K.

Rotate the **right knob** to adjust the G/M. Press the **right knob** to set the value to zero.

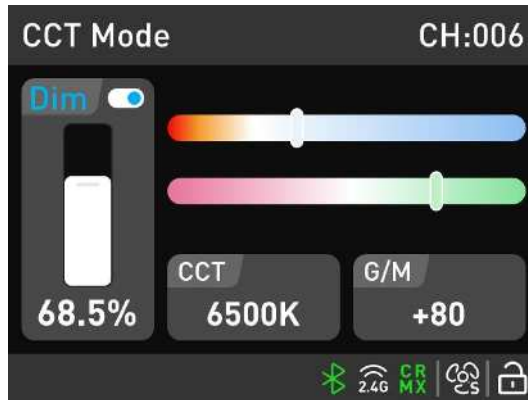

② HSI Mode

Rotate the **left knob** to adjust brightness, the **middle knob** to adjust hue, and the **right knob** to adjust saturation.

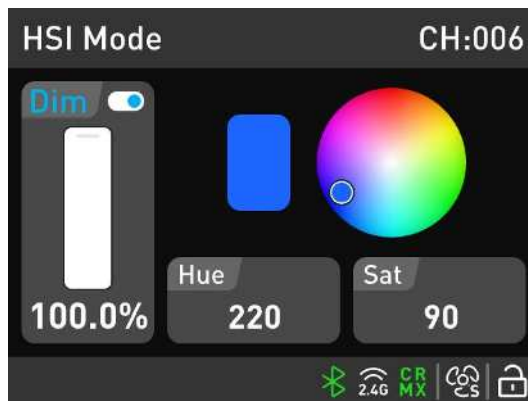

③ HSIW Mode

Rotate the **left knob** to adjust brightness, the **right knob** to select hue, saturation, CCT or G/M, and the **middle knob** to adjust the parameter.

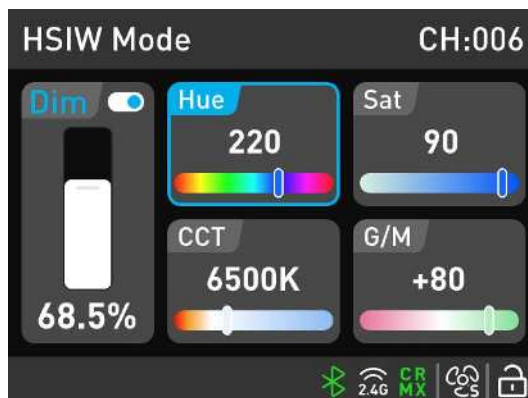

④ RGBW Mode

Rotate the **left knob** to adjust brightness, the **right knob** to select R, G, B or W, and the **middle knob** to adjust the parameter.

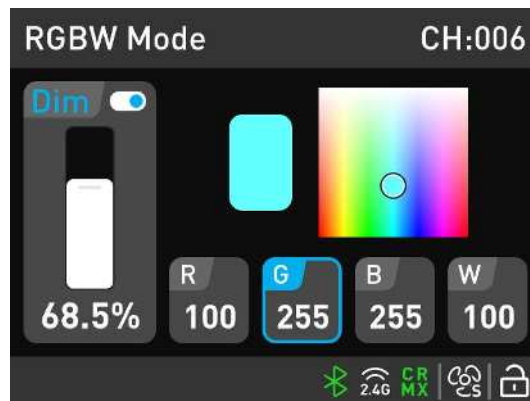

⑤ XY Coordinates

Rotate the **left knob** to adjust brightness, the **middle knob** to adjust the X coordinate value, and the **right knob** to adjust the Y coordinate value.

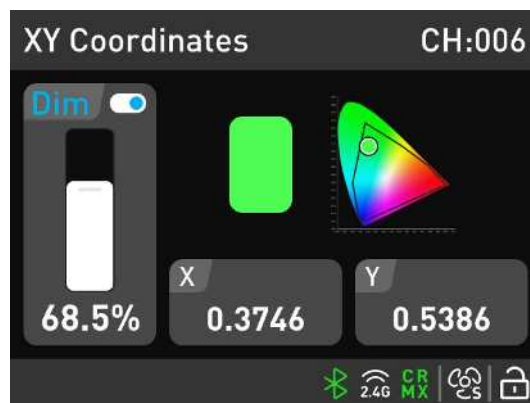

⑥ Gel Mode

Rotate the **left knob** to adjust brightness, the **right knob** to select CCT, Brand or Gel, and the **middle knob** to switch CCT value, gel brands, or select the needed gel.

If the CCT is selected, press the **middle knob** to switch between 3200K and 5600K.

If the gel brand is selected, press the **middle knob** to switch between LEE and Rosco.

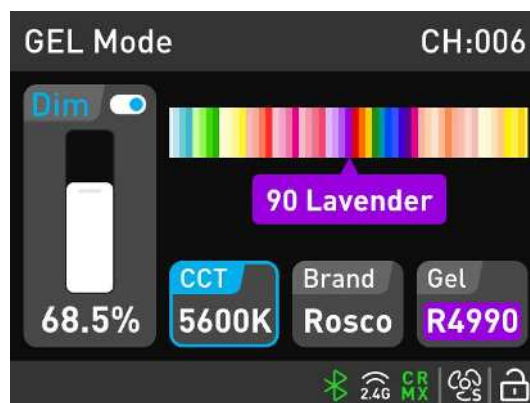

⑦ Effect Mode

Rotate the **right knob** to select the needed effect. Press the **right knob** to enter the interface to adjust parameters.

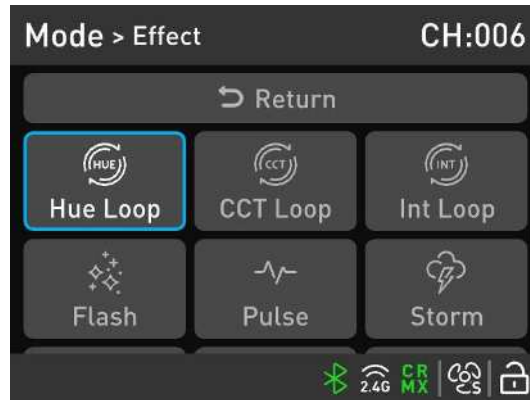

In the effect interface, rotate the **right knob** to select a parameter, the **middle knob** to adjust the parameter value, and the **left knob** to turn on or off the Dimmer Switch.

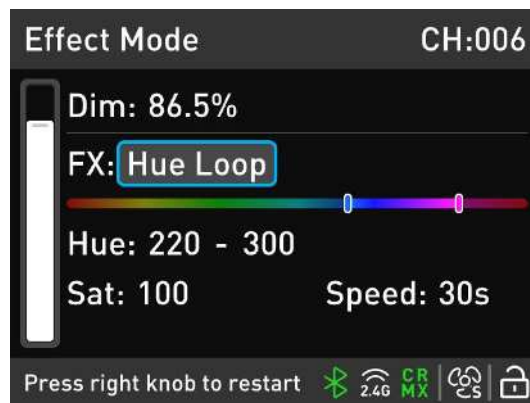

5.1.2. DMX Control

(1) DMX Connection

① Connect the fixture to the DMX console via a DMX cable

A 5-pin shielded cable with a diameter of no less than 0.3mm must be used to connect the light fixture to the DMX console. The fixture is built with a 5-pin XLR socket. If the DMX console is built with a 3-pin XLR socket, an adapter will be required.

② DMX Termination Resistor

When connecting fixtures with DMX cables, the DMX out port of the last fixture in the daisy chain must be connected to a DMX termination resistor (not included). This effectively prevents interference during DMX signal transmission.

(2) DMX Settings

The DMX settings include Address, DMX Mode, DMX Pixel, DMX Reduce Channels, DMX Smoothing, DMX Dimming Curve and Loss Behavior.

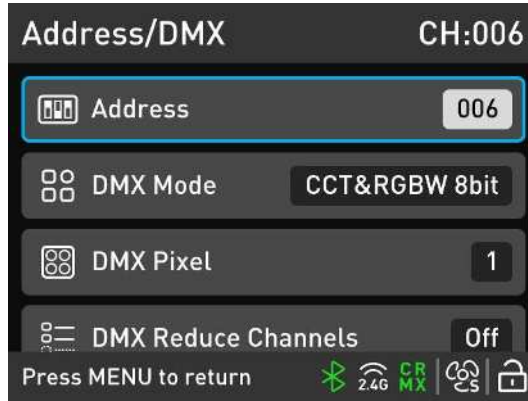

① Address Setting

Enter the address setting interface: Menu → Address/DMX → Address.



② DMX Mode Setting

Enter the DMX mode interface: Menu → Address/DMX → DMX Mode.

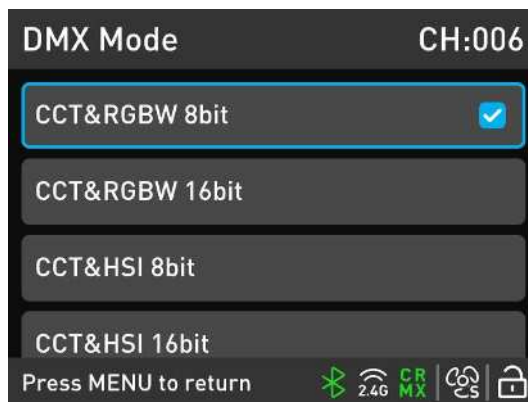

③ Other DMX Settings

The operation methods for DMX Pixel, DMX Reduce Channels, DMX Smoothing, DMX Dimming Curve and Loss Behavior are as below:

Rotate the **right knob** to the corresponding DMX setting option and press the **right knob** to enter the level 3 menu. Rotate the **right knob** to select the parameter, and press the **right knob** to set.

After the DMX settings are finished, and the DMX cable is connected, for detailed operations on controlling the fixture with a DMX console, please refer to the DMX Charts.

(3) RDM Function

- ① Connect the fixture to a console with RDM function using a connection cable.
- ② Control the fixture using a console with RDM function (For detailed operations, please refer to the console manual).

▲ Note: The UID format of fixture is as below:

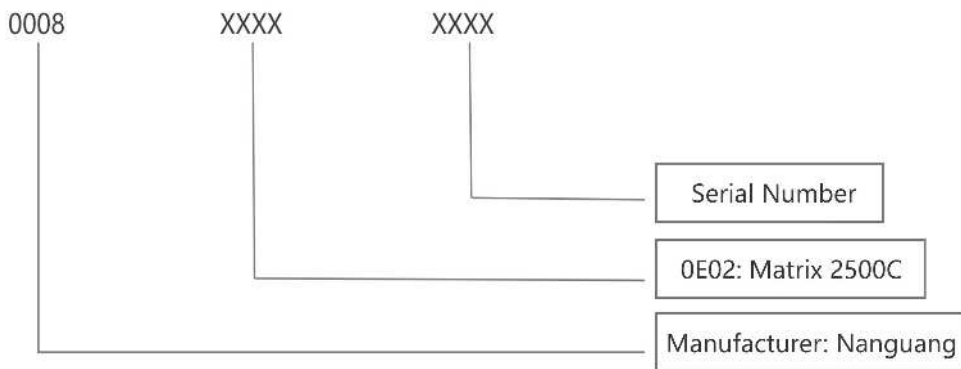

5.1.3. NANLINK APP Control-via Bluetooth

Enter the Bluetooth settings interface: Menu → Wireless Control → Bluetooth Settings.

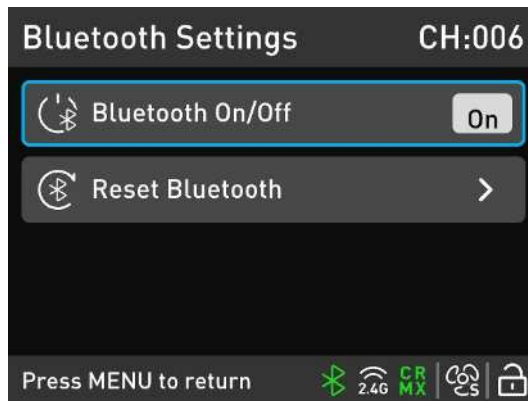

The Reset Bluetooth option is available when the Bluetooth is on.

Enter the reset Bluetooth interface: Bluetooth Settings → Reset Bluetooth.

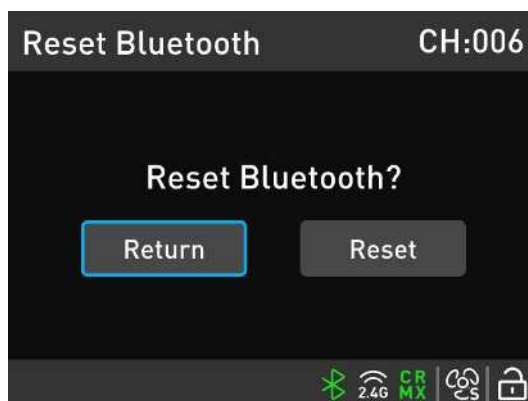

5.1.4. NANLINK APP Control-via NFC

Turn on the Bluetooth on the phone or other devices, and open the NANLINK APP. Go to the “New Fixture” screen in the app, select "Via NFC", and tap "Scan".

Tap the NFC tag on the fixture with the phone. Once the scan is successful, the fixture will be automatically added to the app’s fixture list.

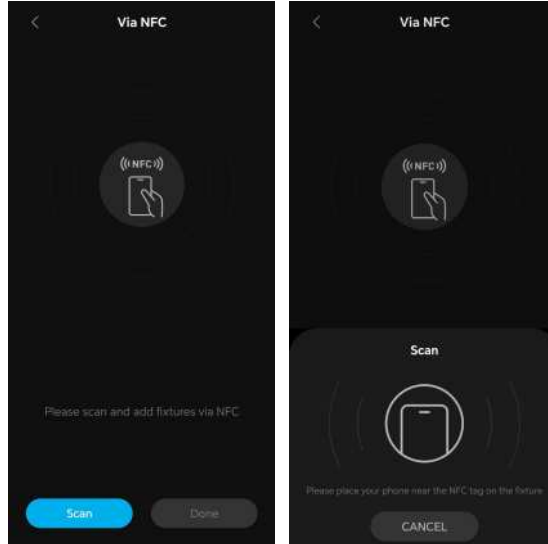

5.1.5. NANLINK APP Control-via 2.4G

The fixture can be connected to the NANLINK App via Bluetooth, NFC, or via 2.4G through the NANLINK transmitter box WS-TB-1.

(1) Turn on the 2.4G.

Enter the 2.4G settings interface: Menu → Wireless Control → 2.4G Settings.

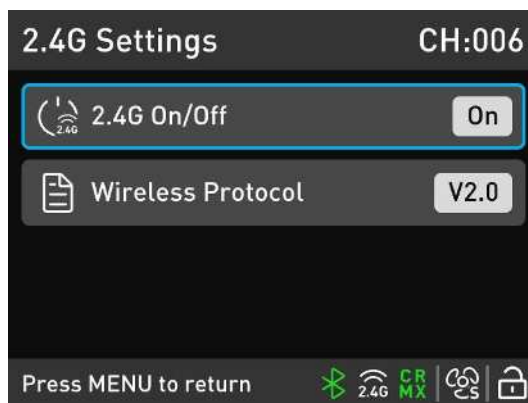

(2) Set the wireless protocol to V1.0.

Enter the wireless protocol interface: 2.4G Settings → Wireless Protocol.



(3) Set the address.

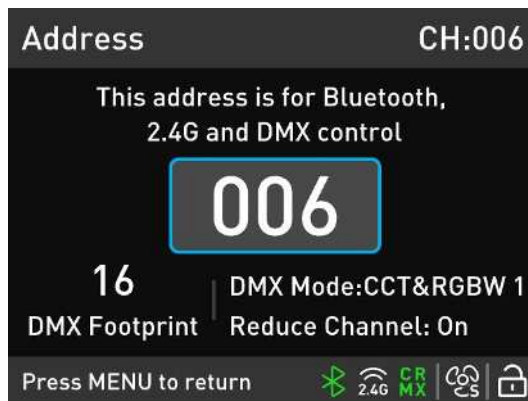

(4) After setting, the fixture can be controlled by the NANLINK transmitter box.

5.1.6. Remote Controller Control

(1) Set the wireless protocol before controlling the fixture by a 2.4G remote controller.

Enter the wireless protocol interface: 2.4G Settings → Wireless Protocol.



▲ Note: The wireless protocol should be set in V2.0 when using the WS-RC-C2 remote controller to control the fixture. Set it in V1.0 when using other remote controllers.

(2) Set the address.

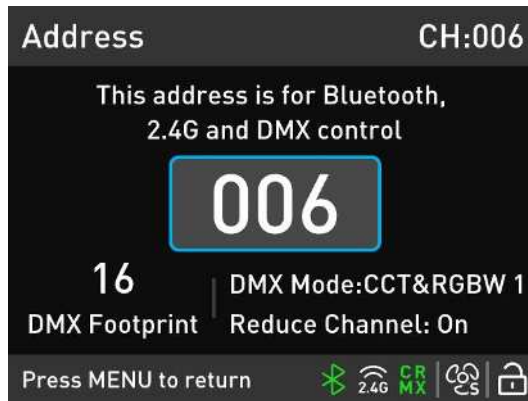

After setting, the fixture can be controlled by a 2.4G remote controller.

5.1.7. CRMX Control

(1) Set the address and adjust the DMX settings before CRMX settings: Menu → Address/DMX

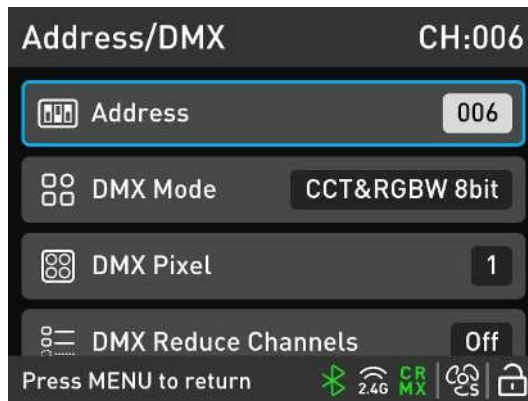

(2) Turn on the CRMX: Menu → Wireless Control → CRMX Settings → CRMX On/Off



The CRMX wireless signal can be received when the CRMX is turned on.

The CRMX wireless signal can't be received when the CRMX is turned off.

(3) Set the radio mode.

Enter the radio mode interface: Menu → CRMX Settings → Radio Mode



①Receiver Mode:

▲Note: The CRMX settings should be set to unlink to allow the fixture to be reconnected to a new fixture in transmitter mode or a transmitter.

A. Set the fixture to CRMX unlink: CRMX Settings → Unlink

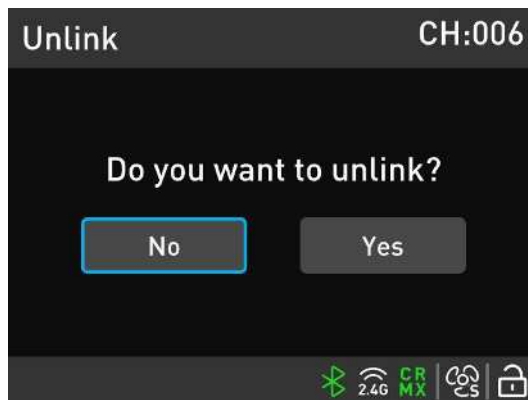

B. Set the CRMX mode: CRMX Settings → CRMX Mode

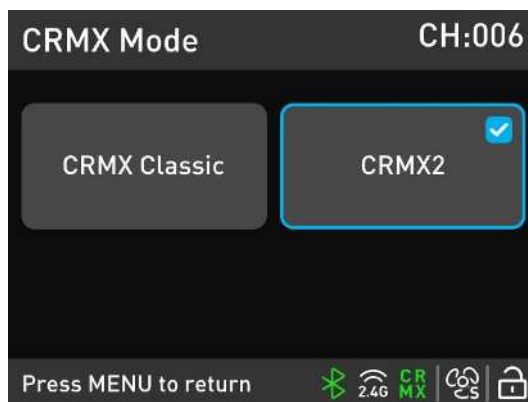

▲Note: The CRMX mode should be set the same on both the transmitter and receiver fixtures.

C. Set the CRMX universe: CRMX Settings → CRMX Universe



② Transmitter Mode:

A. Set the CRMX mode and CRMX universe: CRMX Settings → CRMX Mode, and CRMX Settings → CRMX Universe

B. Set the RF output power: CRMX Settings → RF Output Power



(4) Link the fixture in receiver mode to a CRMX transmitter or a fixture in transmitter mode, there are two pairing methods:

① Manual Pairing

Set the CRMX transmitter or the fixture in transmitter mode to CRMX link: CRMX Settings → Link

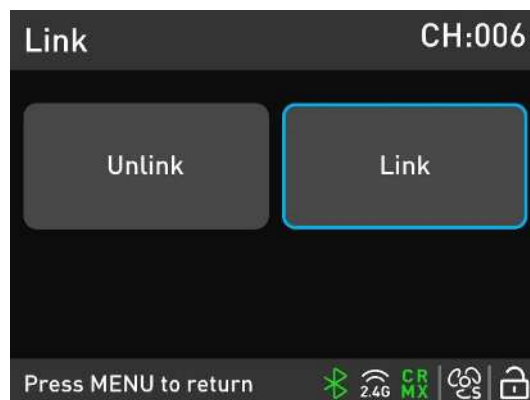

②Pairing via Password

Set the linking key password: CRMX Settings → Linking Key

The linking key consists of eight digits. The default value is "00000000", and each digit can be set from 0 to 9.

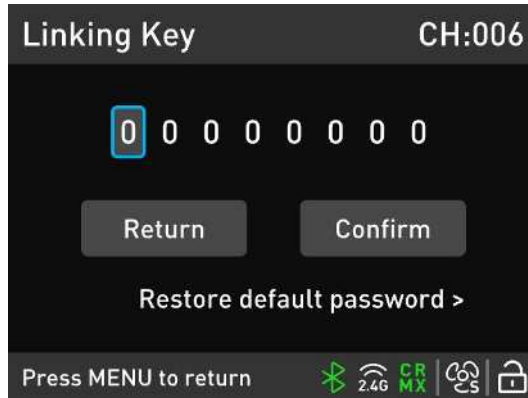

After the linking key password is set, select "Confirm", and the fixture will automatically pair with those having the same linking key and CRMX mode.

5.1.8. Art-Net&sACN Control

The Art-Net/sACN settings include Art-Net/sACN State, Art-Net Universe, and sACN Universe.

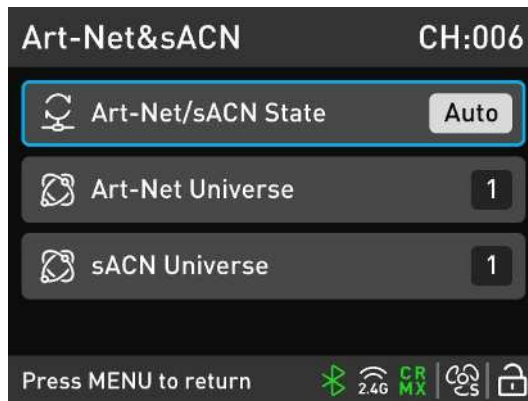

(1) Art-Net/sACN State Settings

Enter the Art-Net/sACN state interface: Menu → Network Settings → Art-Net/sACN State.

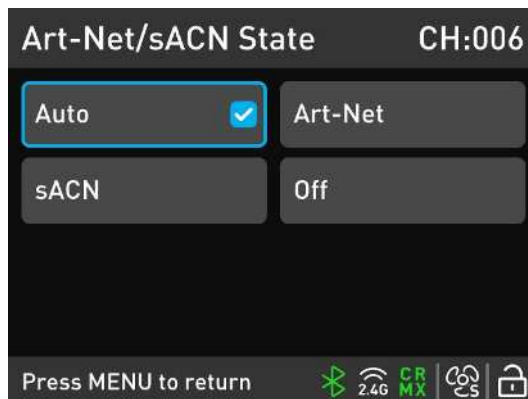

Choose the Auto, the fixture will automatically detect Art-Net or sACN signals based on the network signal.

(2) Art-Net Universe Settings

Enter the Art-Net universe interface: Menu → Network Settings → Art-Net Universe.

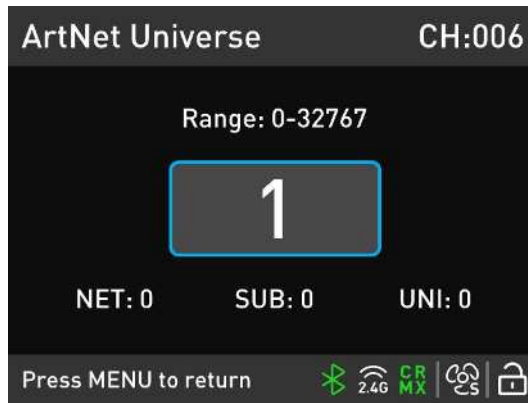

(3) sACN Universe Settings

Enter the sACN universe interface: Menu → Network Settings → sACN Universe.

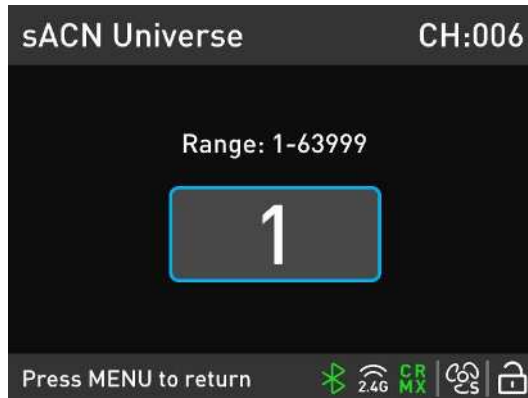

5.2. Menu

5.2.1. Menu Overview

In the menu, there are options including Light Control, Address/DMX, Wireless Control, Network Settings, Display Settings, Fixture Settings and Language.

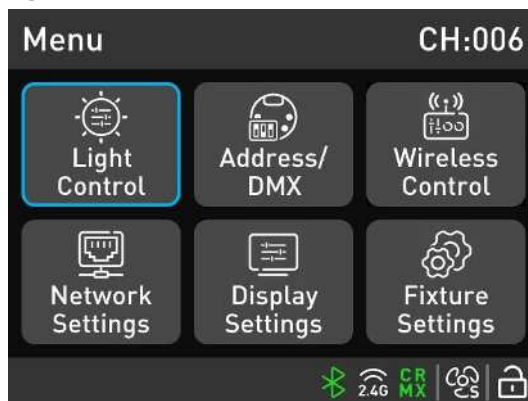

Level 1	Level 2	Level 3
Light Control	Dimming Increment	/
	Zoom Control	
Address/DMX	Address	/
	DMX Mode	
	DMX Pixel	
	DMX Reduce Channels	
	DMX Smoothing	
	DMX Dimming Curve	
	Loss Behavior	
Wireless Control	Bluetooth Settings	Bluetooth On/Off
		Reset Bluetooth
	2.4G Settings	2.4G On/Off
		Wireless Protocol
	CRMX Settings	CRMX On/Off
		Radio Mode
		CRMX Mode
		CRMX Universe
		Linking Key
		Unlink (When the fixture is set to "Receiver Mode")
		RF Output Power (When the fixture is set to "Transmitter Mode")
		Link (When the fixture is set to "Transmitter Mode")
	All Wireless On/Off	/
	Network Settings	Art-Net&sACN
Art-Net Universe		

Level 1	Level 2	Level 3
		sACN Universe
	Network Mode	/
	IP Address	/
	Subnet Mask	/
	Gateway Address	/
	MAC Address	/
Display Setting	Screen Brightness	/
	Rotate Screen	
	Button Backlight	
Fixture Settings	Fan Control	/
	Firmware Update	/
	EXT Port Settings	Firmware Update
		EXT Port Info
	Reset All Settings	/
	Fixture Info	/
Language	/	/

5.2.2. Menu Operation

In the menu, rotate the **right knob** to select an option and press the **right knob** to enter the next level menu. In the level 2 or level 3 menu, press the **MENU button** to return to the previous menu.

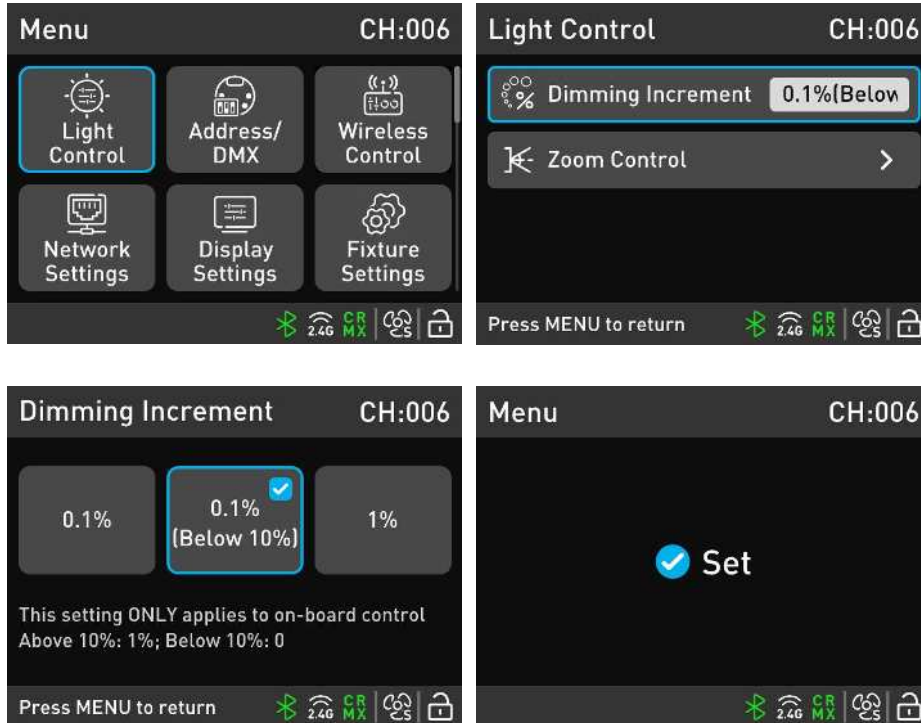

5.2.3. Others

(1) Dimming Increment

When 1% is selected, the dimming range is 0% to 100%, with increment of 1%.

When 0.1% is selected, the dimming range is 0.0% to 100.0%, with increment of 0.1%.

When 0.1% (Below 10%) is selected, if the brightness is set between 0.0% and 9.9%, the increment is 0.1%; if the brightness is set between 10% and 100%, the increment is 1%.

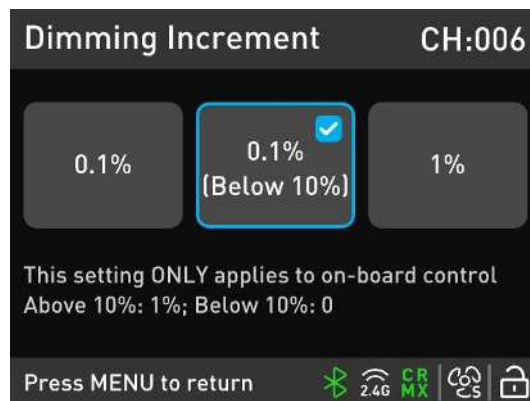





(2) Fan Control

When the fan is in Smart or Full Speed mode, the maximum brightness of the fixture is 100%.









When the fan is in Low Speed mode, the maximum brightness of the fixture is 50%.

When the fan is in Off mode, the interior fan will stop working, and the maximum brightness of the fixture is 10%.

Description for Fan Icon:

Icon	Description
	Fan (Smart)
	Fan (Full Speed)
	Fan (Low Speed)
	Fan (Off)
	Fan Abnormal

(3) Description for Wireless Icon in the Bottom Toolbar:

Icon	Description
	Bluetooth Not Paired
	Bluetooth Paired
	Bluetooth Off
	2.4G On
	2.4G Off
	CRMX Unlinked
	CRMX Linked
	CRMX Off

(4) Firmware Update

Put the firmware files into the root directory of the USB drive (ensure the versions of the firmware files are the same), insert the USB drive into the USB-A port, enter the Menu → Fixture Settings → Firmware Update, the system will automatically search for the firmware files.

(5) EXT Port Firmware Update

Put the firmware files of the EXT port into the root directory of the USB drive (ensure the versions of the firmware files are the same), insert the USB drive into the USB-A port, enter the Menu → Fixture Settings → EXT Port Settings → Firmware Update, the system will automatically search for the firmware files.

▲ Note: ①Please do not rename the firmware files.

②Ensure the USB drive is formatted to FAT, FAT32 or exFAT.

③If the instruction "The versions of the firmware files don't match. Please check the files and try again" is displayed, pls check if the versions of the firmware files are the same.

④If the instruction "Missing parts of firmware files, please check the files and try again" is displayed, please ensure that all firmware files are stored on the USB drive.

⑤If the instruction "No firmware found, press MENU to return" is displayed, please check whether the firmware files are correct, whether they are stored in the root directory of the USB drive, and whether the USB drive is formatted as FAT, FAT32 or exFAT.

⑥If all the above steps have been completed and the firmware files still cannot be found, please format the USB drive again.

⑦If the fixture still cannot recognize the USB drive, please replace the USB drive.

5.3. Preset

The preset function is used to save lighting settings for quick access. Press the **PRESET button** to enter the preset interface.

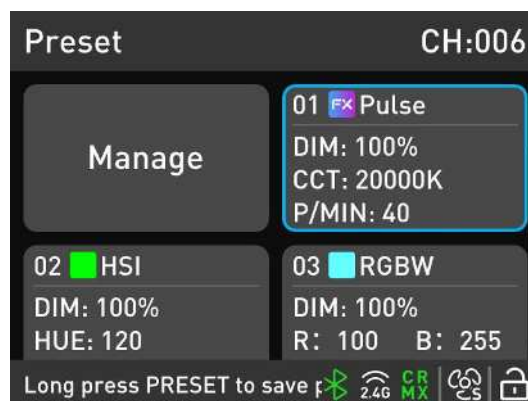

5.3.1. Save Preset

After completing the lighting settings, press the **PRESET button** for 3 seconds to enter the preset interface. Rotate the **right knob** to select a slot and press the **right knob** to save.

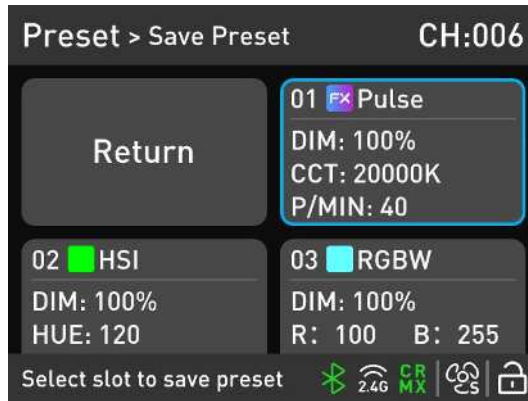

If a preset is already saved in this slot, pressing the **right knob** will show an instruction for replacing the preset. Select "Confirm" to replace the existing preset with the new one.



5.3.2. Apply Preset

In the preset interface, rotate the **right knob** to select the needed preset. Press the **right knob** to apply the preset's setting, and the screen will switch to the corresponding setting interface.

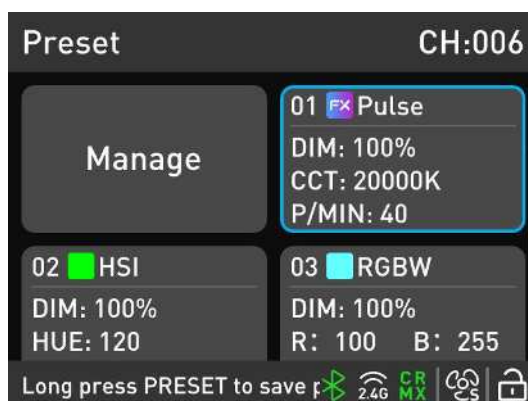

5.3.3. Manage Preset

In the preset interface, rotate the **right knob** to Manage Preset, and press the **right knob** to enter the preset manage interface, any preset can be removed in this interface.

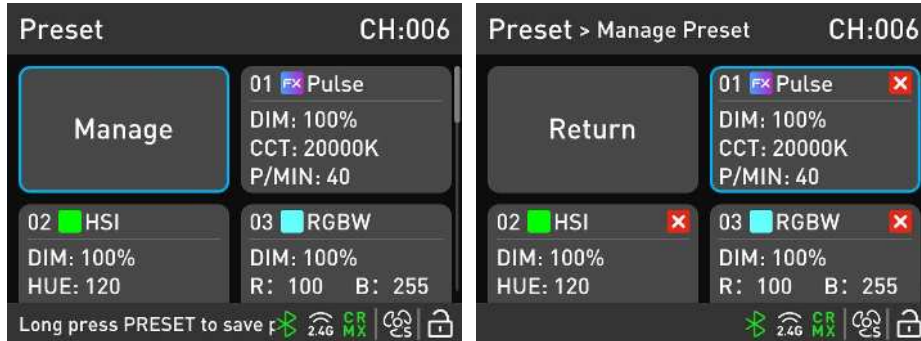

Rotate the **right knob** to select the preset to be removed. Pressing the **right knob** will show an instruction, select "Confirm" and press the **right knob** again to complete the removal.

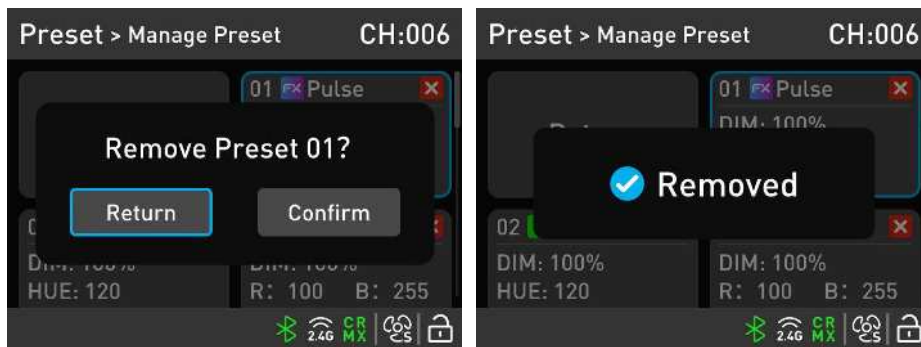

5.4. Lock

Long press the **LOCK button** to lock the lighting state. Long press the **LOCK button** again to unlock.

The lock setting only locks the control panel; the fixture can still be controlled via DMX signals (including Art-Net, sACN) and all wireless signals (including CRMX, wireless DMX, 2.4G, Bluetooth).

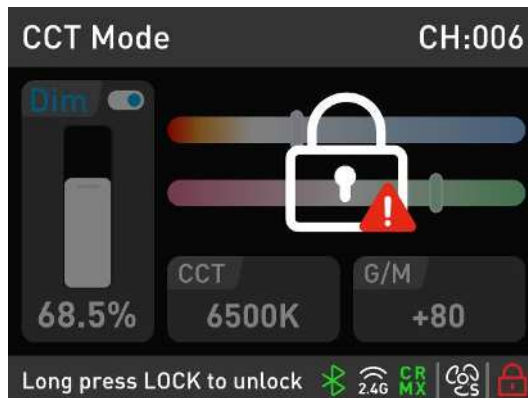

▲ Note: If the fixture is turned off while in a locked state, it will remain locked when turned on again. To unlock, long press the **LOCK button**.

5.5. NFC Function

(1) Turn on the NFC function on the mobile phone or tablet, open the Nanlink App, and tap the NFC Configuration interface:

- ①Manual input: Select the corresponding fixture information, then set the DMX parameters in the drop-down list.
- ②Automatic pull: Tap the pull icon, place the phone near the NFC tag on the fixture, the App will read the fixture's DMX parameters, and the parameters can be adjusted as needed.

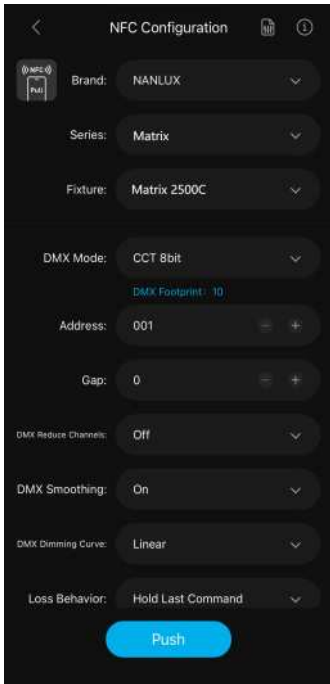

①Manual Input

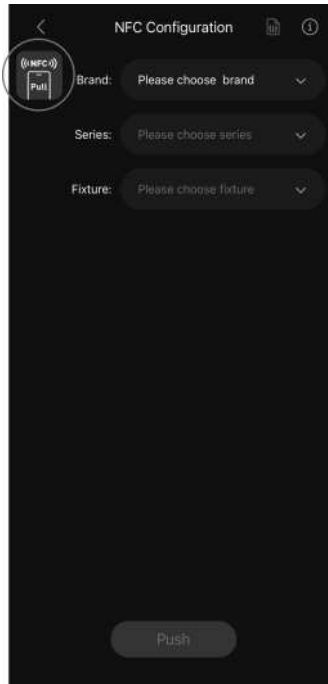

②Automatic Pull

(2) Tap Push, place the phone near the NFC tag on the fixture, the DMX parameters set in the App will be applied to the fixture.

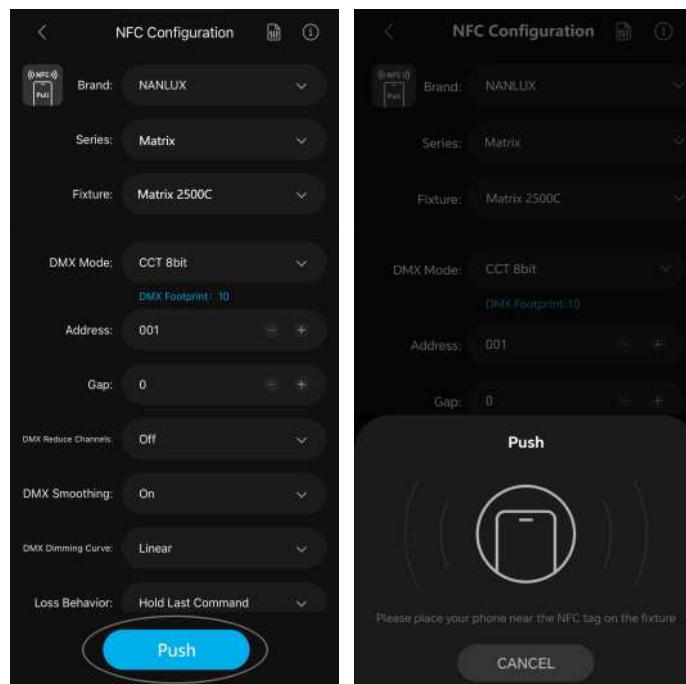

▲ Note: The pull and push interfaces may vary depending on the phone and App version. Please refer to the actual display.

6. Troubleshooting for Common Issues

Issues	Troubleshooting Guide
The fixture can't power up.	<ol style="list-style-type: none"> 1. Please check whether the connections between the cable, fixture, and power outlet are loose. 2. Please check whether the power source voltage and frequency are within the specified range.
The fixture can be operated manually, but DMX control is not working.	<ol style="list-style-type: none"> 1. Please check whether the DMX address setting is correct. 2. Please check whether the DMX cable is connected correctly and without damage.
The fixture flickers.	<ol style="list-style-type: none"> 1. Please check whether there are any high-temperature objects nearby that could cause the operating environment temperature to become too high. 2. Please check whether the fixture is in running any special effect.
The display screen is on, but the fixture cannot be operated.	Please check whether the screen shows "🔒". Long press the LOCK button for 3s to unlock.
The fan doesn't work.	Please turn on the fixture and check whether the fan is Off.

Please scan the QR code for more details.



【DMX Charts】



【Nanlux Website】



【Nanlink App】

WWW.NANLUX.COM

NANLUX

 +86-754-85751187

 info@nanlux.com

 Dongli Section, Highway 324, Chenghai, Shantou City, Guangdong Province, China